



DS-1271ZJ-130

Pendent Mounting Bracket for
Dome Camera

Features:

- Aluminum alloy material with surface spray treatment
- Waterproof design
- Cable hole on bracket makes the feature better
- Design of cap is for convenient wiring

Dimension:

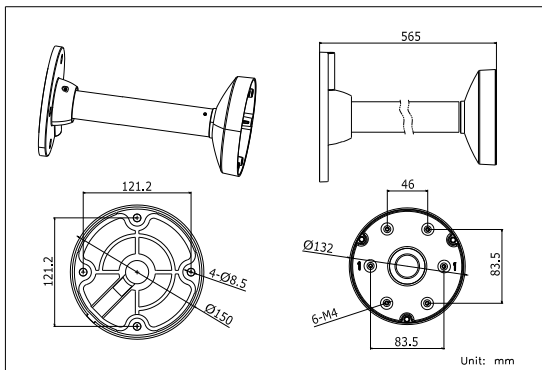

Order Model:

DS-1271ZJ-130

Parameter:

Model	DS-1271ZJ-130
Parameters	Pendent Mounting Bracket for Dome Camera
Appearance	Hikvision White
Material	Aluminum Alloy
Dimension	Φ 150X565mm
Weight	1900g

Notice:

- The bracket should be installed on flat wall
- The wall must be capable of supporting over 3 times as much as the total weight of the camera and the mount.
- The maximum load capacity of the bracket is 4.5KG

Model Suitable:

DS-2CD7X3PF(NF)-E(I)(Z), DS-2CD793PFWD-E(I)(Z), DS-2CD793NFW-E(I)(Z), DS-2CD7X4FWD-E(I)(Z)
DS-2CD7XXF-E(I)(Z), DS-2CD783F-EP, DS-2CD4112F-(I), DS-2CD4112FWD-(I), DS-2CD4124F-(I), DS-2CD4132FWD-(I)

Installation Step:

- ① Choose the appropriate wall to install the ceiling plate and wiring

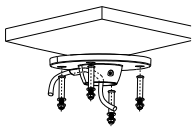

- ② Connect pole and adaptor cap; wiring and screw up

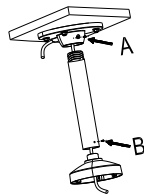

A & B: Fastening screw

- ③ Screw up in A & B and fix pendent pole and cap

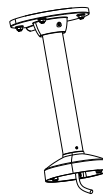

- ④ Screw the dome to the cap

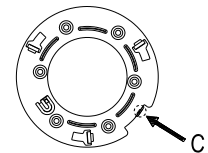

C: Bayonet of dome adaptor

- ⑤ Check the hole site and fix adaptor to cap

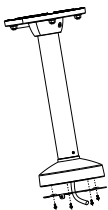

- ⑥ Wiring and fix dome camera to adaptor

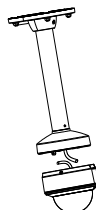

- ⑦ Rotate the dome camera moderately and screw up the fastening screw

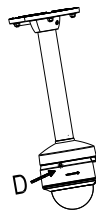

D: Fastening screw on dome

- ⑧ Installation complete



Note: The actual dome camera may vary from the picture above.